

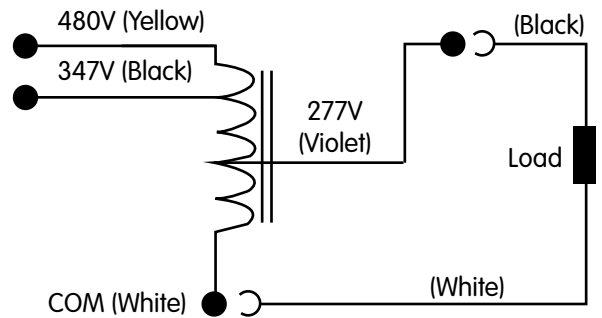

Step-Down Transformer

Model No.	HL-DT-160VA-480-277V
Product Type	Step-Down Transformer
Rating (VA)	160
Vin Vout	480/347VAC 277VAC
Frequency	60 Hz
Status	Production

Input Voltage(V)		480/347	
Max Input Circuit (A)		0.36/0.50	
Max Output Circuit (A)		0.58	
Max. Load (VA)		160	
Output Voltage (V)		277	
Full Load	EFF. (%)	92/94	
	THD (%)	4.3/4.1	
	Power Factor	0.987/0.987	
UL Class H 180 Temp. Code		A	
Dimension (inches/mm)	Basic Dimensions	A*	3.07±0.04/78±1
		B (Max)	4.06/103
		W	1.93±0.04/49±1
		H	1.61±0.04/41±1
	Installation Dimensions	M1	1.56/39.6
		M2	3.80±0.04/96.6±2
		M3	0.57/14.4
		M4	4.02±0.04/102±2
		L	4.25±0.04/108±2
		Max Net Weight (lbs.)	
Max Net Weight + LW (lbs.)		2.44	
Lead Length (inches)		8±0.5	

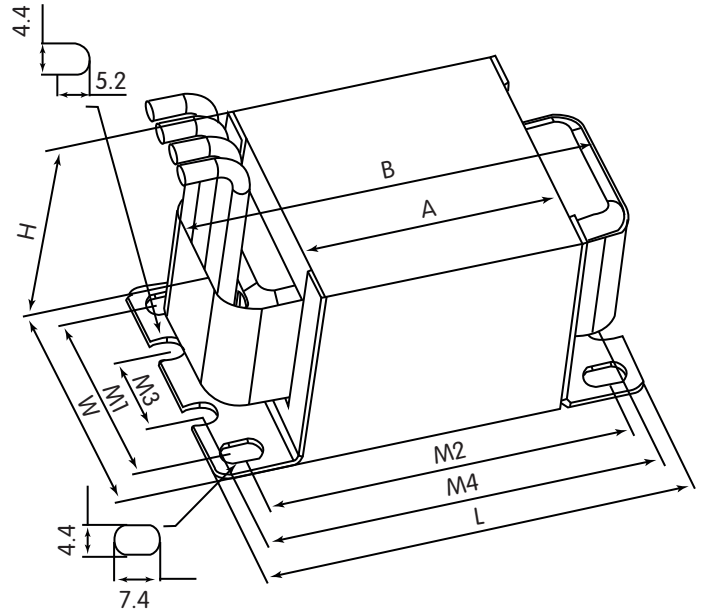

A* Does not cover the thickness of the two holders
 *Lead Type: (AVLV2, AVLV8), Type 3135, No. 18 AWG (or Equivalent),
 Rated 200° C, 600V. Strip 10mm Tin Plated.
 347V lead wire is pre-insulated

Product Standards: UL 5085-1, UL 5085-2
 UL CCN: XPTQ1, XPTQ7

Document No.	HL-DT-160VA-480-277V
Date	2018-04-05 (yyyy-mm-dd)

Data is based upon tests performed in a controlled environment and represents relative performance.
 Actual performance may vary depending on Ballast and Operating Conditions.
 Specifications are subject to change without notice.